

Thank you for purchasing this BATHROOM BUTLER Product.

## Toilet Butler - Assembly Instructions

(BTA-9108-VSA3.1)

### PRODUCT LIMITED GUARANTEE

All components of this quality Bathroom Butler stainless steel product are guaranteed against any defects in materials or workmanship for a period of 5 years from date of purchase, as printed on the sales docket, which must be provided as proof of purchase. Excluded from this limited guarantee are: damages resulting from an "Act of God" including but not limited to lightning and floods; fair wear and tear, wilful damage, negligence, repair of product without the approval of Bathroom Butler; damage as a result of incorrect assembly. Damage resulting from misuse will render the warranty null and void.

The manufacturers liability is limited to repair or replacement of the product only, and the decision to repair or to replace is at the sole discretion of Bathroom Butler. No claim for consequential damage and/or labour and/or transport will be entertained.

This limited guarantee is only valid when the product has been purchased from an authorised reseller or country/ territory distributor and is only valid within the geographical borders of the country/territory that it was originally purchased. This limited guarantee only extends to the original purchaser of this Bathroom Butler product and is not transferable.

### NOTE

Products in diagrams used are for graphical representation only, actual products may vary from model to model.

## 1. Fasteners Supplied:

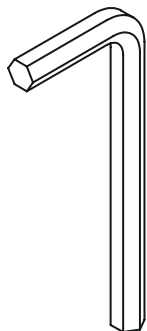

**(A) x1**  
(4mm)



**(B) x1**  
(2.5mm)

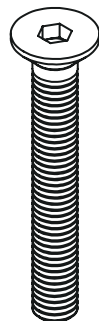

**(C) x1**  
(M6X50)

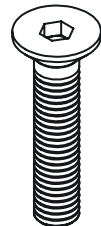

**(D) x1**  
(M6X30)



**(E) x2**  
(M4X8)

\* Due to the fact that Bathroom Butler is always actively researching new methods and/or materials with a view to further improving our products you may notice some differences between the parts you received and the assembly method described herein. Please understand that this instruction leaflet is intended as a guide only.

## 2. Parts Supplied:

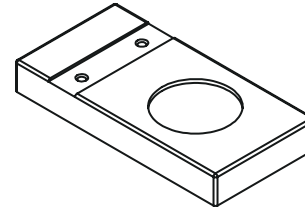

**(F) x1**  
(Base)

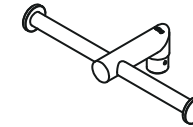

**(G) x1**  
(Top)

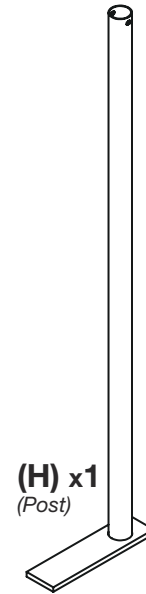

**(H) x1**  
(Post)

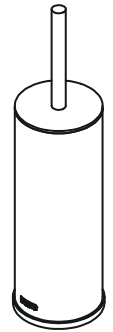

**(J) x1**  
(Toilet Brush)

## 3.

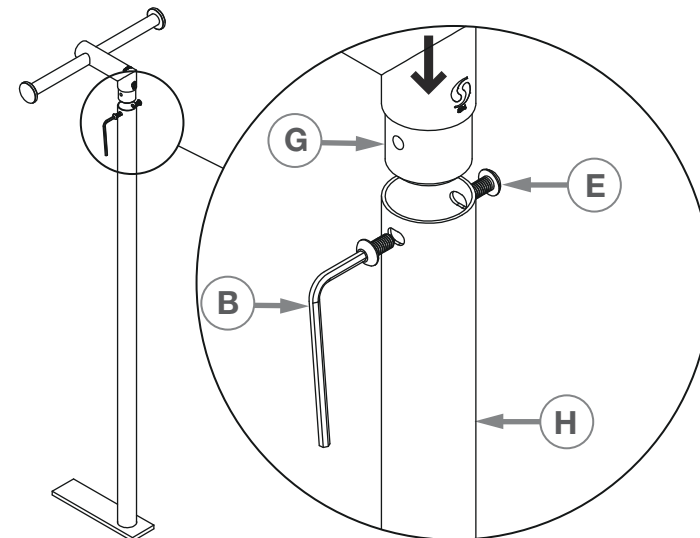

3. contd...

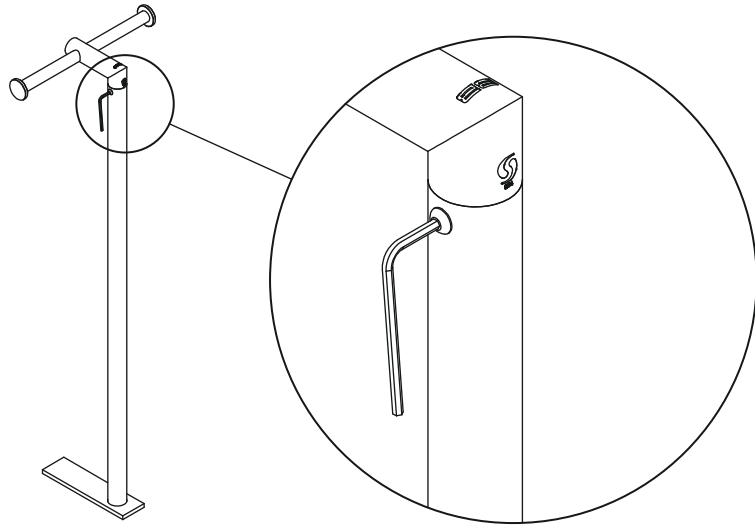

4.

