

NATURAL 5 Bar 500mm STR-TDC 230V

GRADE 304 Stainless Steel

Model/SKU: NAT05221-TDC-####*

(*where #### is the relevant finish code)

HTR Technical Specifications:

Size: 524mm (width) x 735mm (height)

Power: 65 Watts

Current: 0.28 Amps

Volts: 230 VAC

IP Rating: IPX5

Controller Fitted: TDC Timer (TDC)

Controller Features:

- 4 On/Off programs in a 24hr period
- Temperature Adjustment
- 4 Modes of operation
- Screen Auto-Lock
- One button push - QUICK RUN
- 24hr Clock

Controller Technical Specifications:

INPUT Voltage Range: 190VAC~250VAC

Operating Frequency: 50 Hz \pm 2%

Load Capability: 0.18A~4A

Load Control Range: 40~100%

Standby Current: 3.5mA

Suggested Height of Electrical Outlet = 1050mm

(this is only an indication as every installation is different)

NOTES:

*EO Denotes DUAL ENTRY Electrical Outlet connection

*TDC Denotes location of TDC Timer

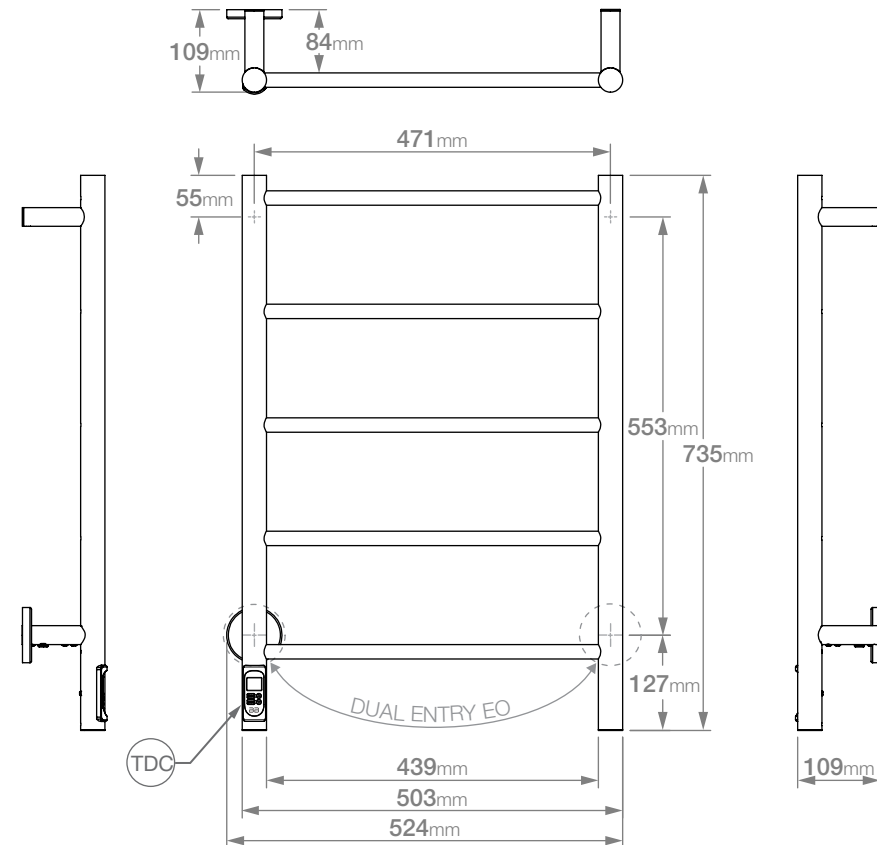

Dimensions given are in mm. Bathroom Butler® reserves the right to alter and/or remove designs from time to time without prior notice. This drawing is to be used for reference purposes only. E & O.E.

Copyright Bathroom Butler® 2021

BB™ BATHROOM
BUTLER



USA: 631.464.2851 • customercare@bathroombutler.com • www.bathroombutler.com/us
South Africa: 0860 104 653 • info@bathroombutler.co.za • www.bathroombutler.com/za
Australia: +61 436 487 420 • info_au@bathroombutler.com • www.bathroombutler.com/au
Mauritius: 230 242 1248 • sales@lisinggroup.com • www.bathroombutler.com

Document version 033

Product version 030